

CONFIGURATIONS

CLOISON (pose du sol au plafond)

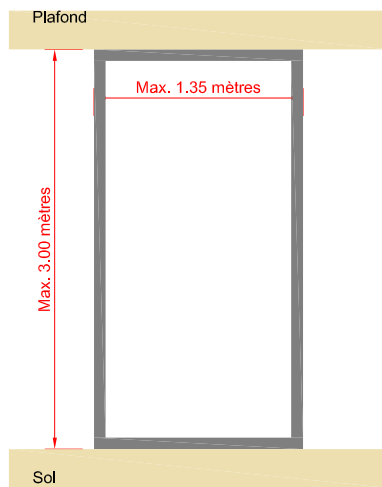

Fixation par vissage (au moins 2 côtés)

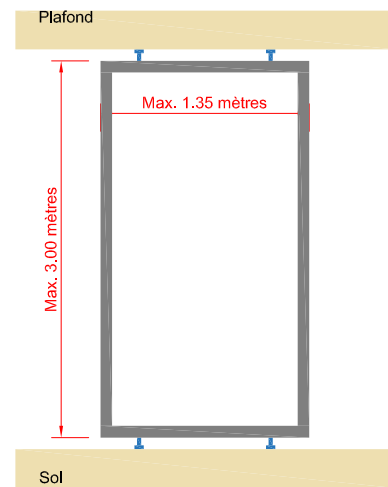

Pose avec des vérins à vis réglables de +/- 2 cm

CONFIGURATIONS

CLAUSTRA (pose au sol sur pieds)

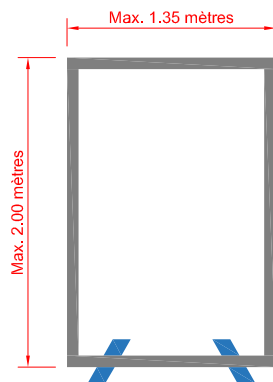

Position Portrait

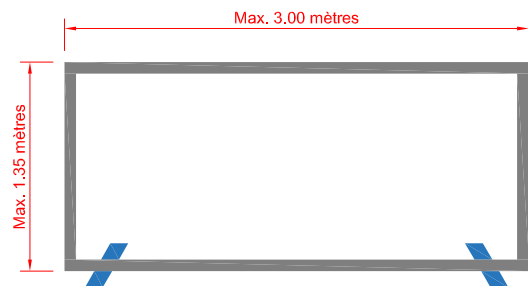

Position Paysage

CONFIGURATIONS

BENCH (pose sur bureaux)

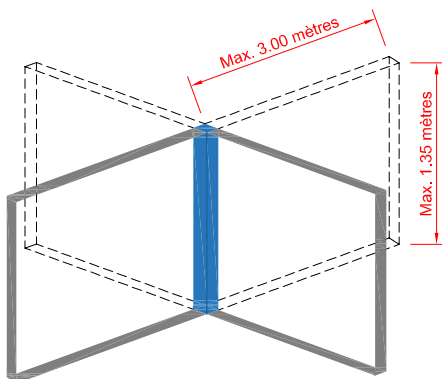

Modules de 2, 3 ou 4 panneaux fixés à 90° sur potelet central

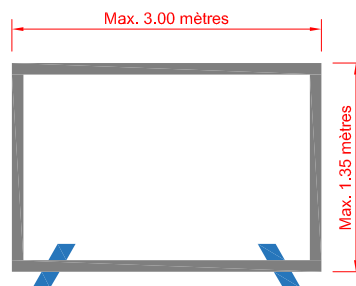

Sur pieds

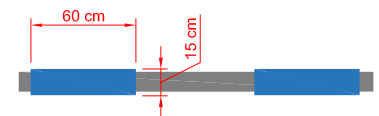

Pieds